

E-Tailgate lock for VOLKSWAGEN AMAROK 2010-2022

(V6 WITH KEY HOLE)





Installation Instruction



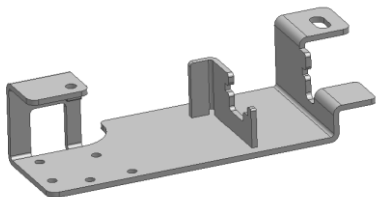
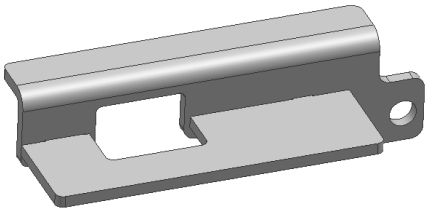
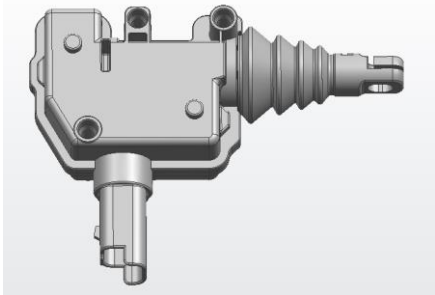

CAUTION:

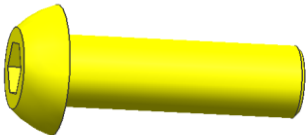
The figures here are for reference only and may have differences with the actual product you received, however they share the same assembly way.

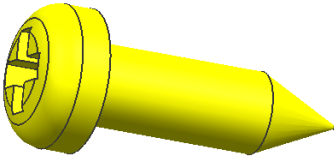
Please read the instruction completely for easy installation, which will also help you to avoid scratches or other potential damages to your appealing car.

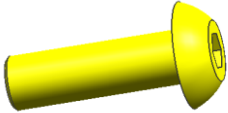
PART LIST:

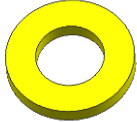
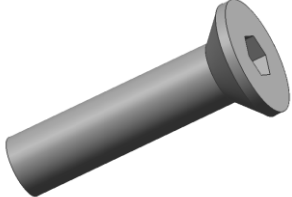
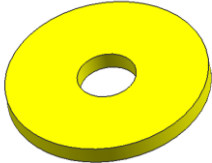
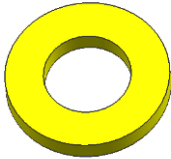
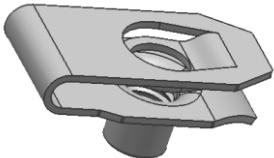
NO.	QTY	NAME	NO.	QTY	NAME
①	1	 Bracket 1	②	1	 Bracket 2
③	1	 Actuator	④	1	 Wire harness (Universal)
⑤	2	 T-Shaped clamp (wire harness 0.2-0.5)	⑥	1	 Hexagon Socket Button Head Screws M6_20
⑦	1	 Hex flange nut M6	⑧	3	 Phillip tapping screw ST4.8_16

⑨	1	 Hexagon Socket Button Head Screws M5_16	⑩	1	 M5 Spring Washer
⑪	1	 M5 Flat Washer (5x10x1)	⑫	1	 Inner Hex bolt M6_25
⑬	1	 D6 Larger Washer (6x18x1.6mm)	⑭	2	 M6 Flat Washer (6x12x1.6)
⑮	2	 Clip Nut M6	⑯	1	 Allen Wrench S=3
⑰	1	 Allen Wrench S=4			

STEP ONE: Brackets Installation:

Remove the steel cover plate on tailgate by loosing the screws, remove the whitih clicp also.

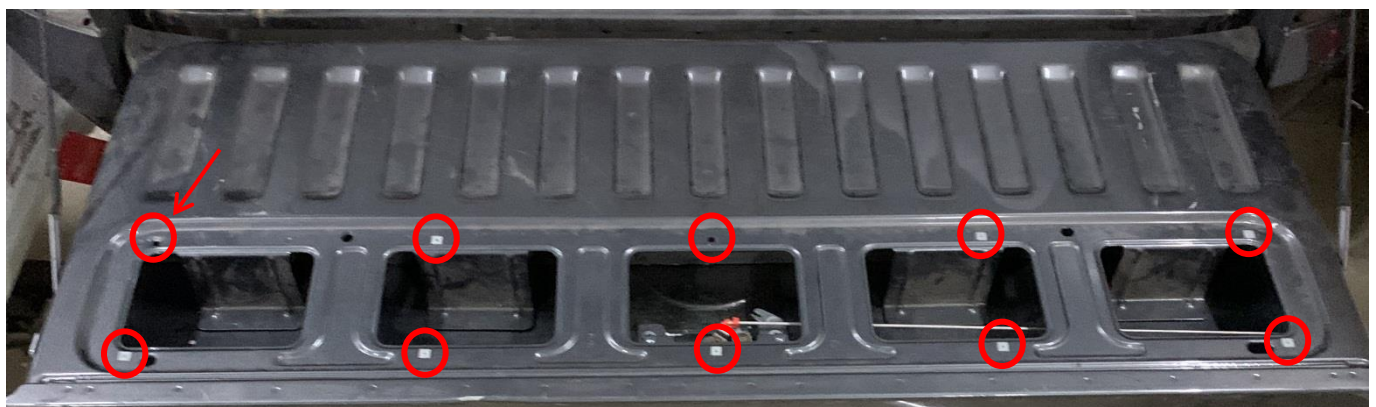

Installation Fig.

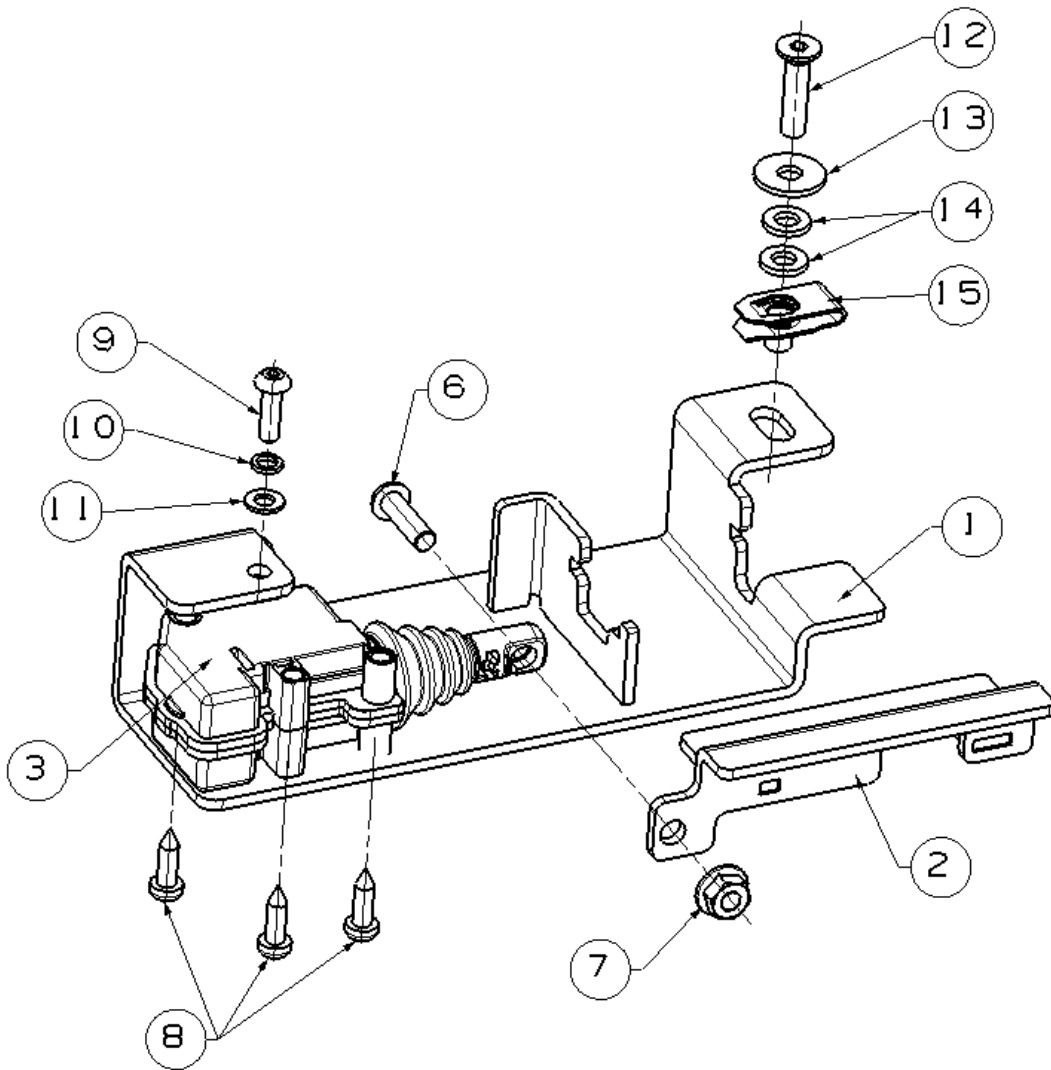

As below photo shows, install ① bracket 1, ③ actuator ⑮ Clip Nut M6 with ⑧.

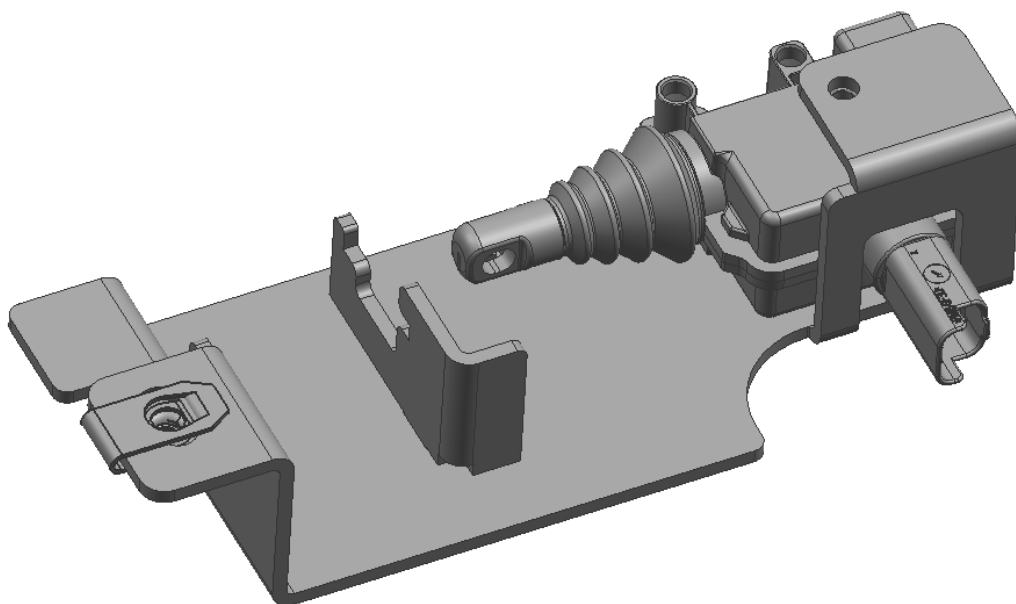

Route the ④ wiring harness out of the tailgate.



Connect the wiring to the ③ actuator



As below picture shows, put the bracket assembly inside of the tailgate.

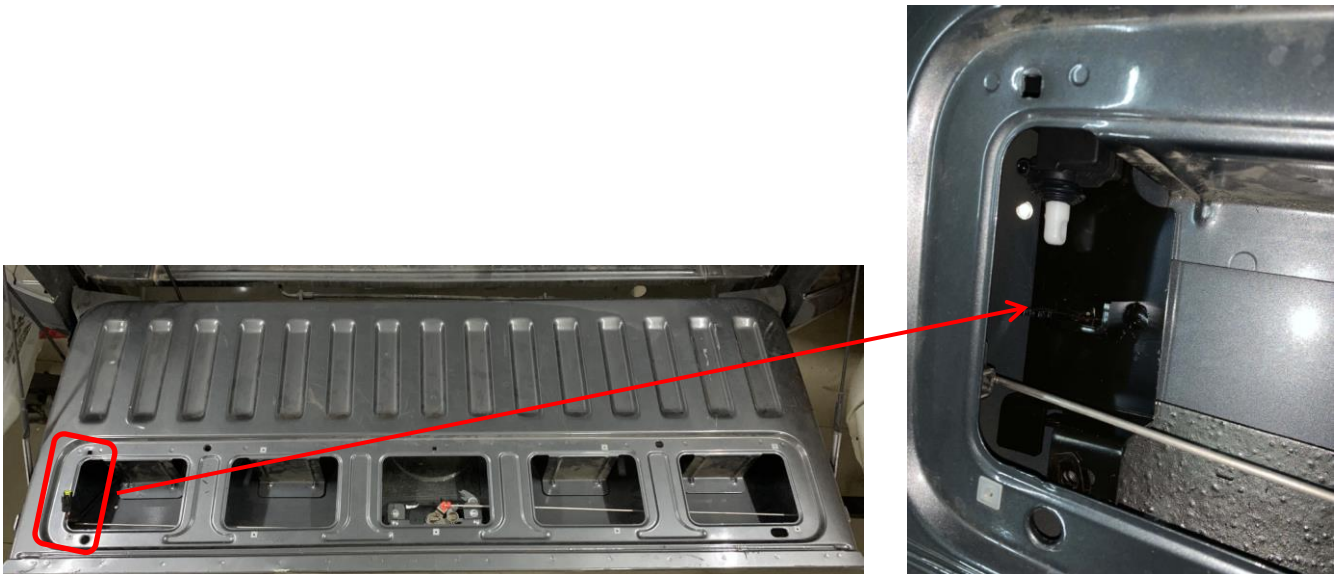

Install ② Bracket 2, fasten it with ⑥ & ⑦.



Adjust the bracket assembly to appropriate position, test the locking function. Then reinstall the cover plate on tailgate.

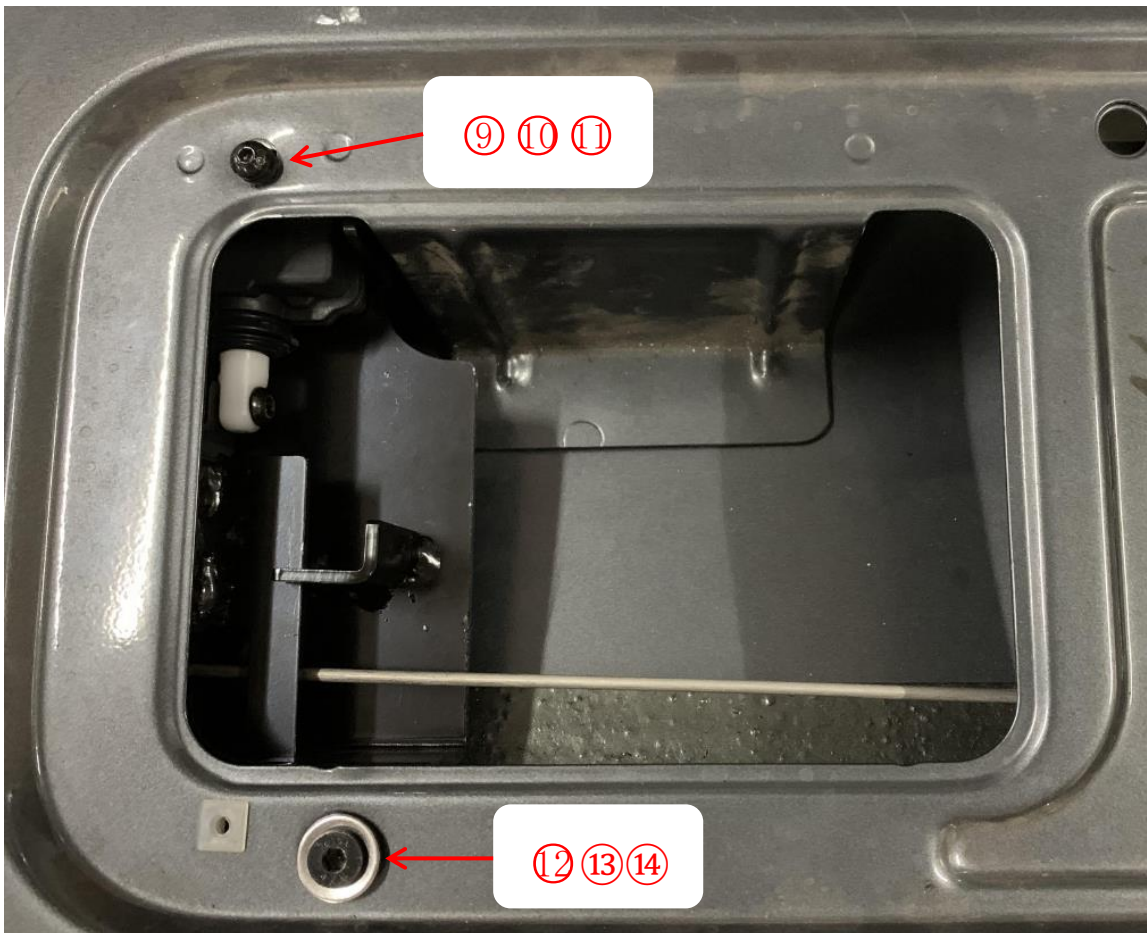

STEP TWO : Wire harness:

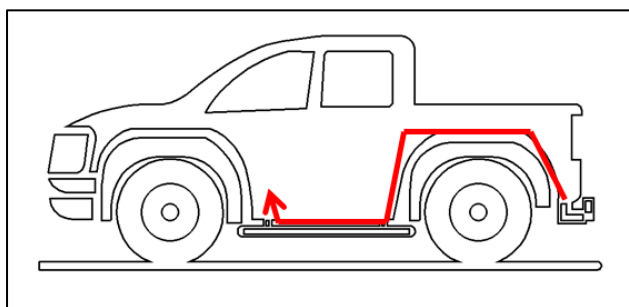

Run the wire harness from tailgate to fender flare through chassis.

Wires are located in the LOOM LEADING TO FRONT PASSENGER DOOR, NEED TO REMOVE PASSENGER KICK PANEL.

Test the tailgate lock function with the remote control. Then reinstall the fender flare and tailgate cover.
Finished